

Article number: 4320000601

Description: Rota-fix shaft-hub connection A 60x90  
Stainless Steel

## Measures

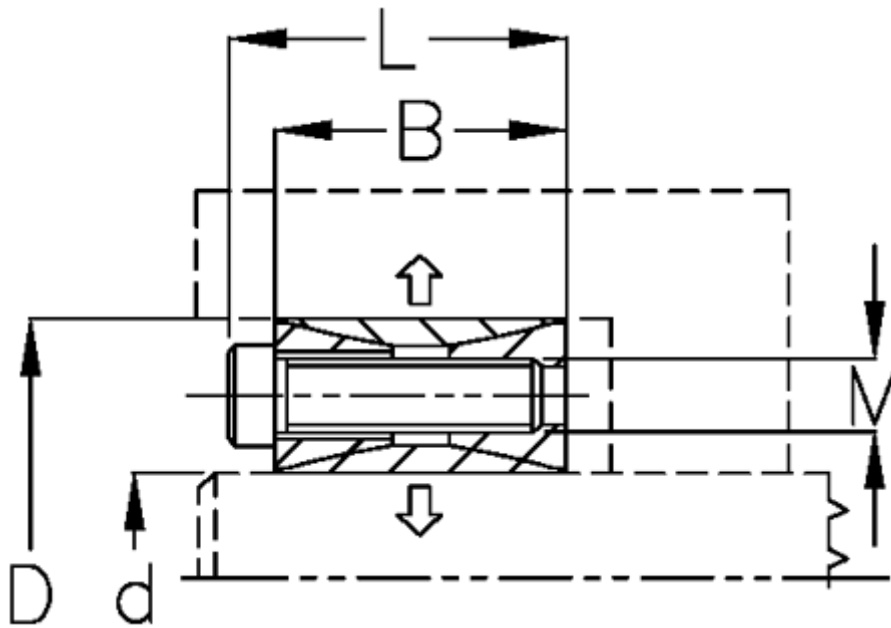

B mm	= 24
d H8 mm	= 60
D mm	= 90
Fit tolerance	= Aksel k11-h11, Nav N11-H11
F kN torque	= 51.3
L mm	= 32
M mm	= M8
P N/mm <sup>2</sup> surface pressure on shaft/hub	= 45

Surface roughness	=
T N m torque	=
Ts N m bolt tightening torque	=